

⚠WARNING:

If the information in these instructions is not followed exactly, a fire or explosion may result, causing death, personal injury, or property damage.

⚠For Your Safety!

- Do not store or use gasoline or other flammable vapors and liquids in the vicinity of this or any other appliance. To do so may result in an explosion or fire.
- Installation and service must be performed by a qualified installer, service agency, or the gas supplier.

What to Do If You Smell Gas

- Do not try to light any appliance.
- Do not touch any electrical switch; do not use any phone in your building.
- Immediately call your gas supplier from a neighbor's phone. Follow the gas supplier's instructions.
- If you cannot reach your gas supplier, call the fire department.
- Do not return to your home until authorized by the gas supplier or fire department.

Do not destroy manual. Please read carefully and keep in a safe place for future reference.

⚠WARNING:

This water heater is not suitable for use in manufactured (mobile) homes.

TANKLESS WATER HEATER

USE AND CARE MANUAL

With Installation Instructions
for the Installer

Noncondensing 199,900 Btu/hr, 180,000 Btu/
hr, and 150,000 Btu/hr Models



CONTENTS

Important Safety Information

Safety Precautions 2-8

Product Information

Product Information..... 8

Specifications..... 9, 10

General Descriptions.....11, 12

Using Your Water Heater

Setting the Water Temperature 13, 14

Caring for Your Water Heater

Water Heater Inspections..... 15, 16

Care and Cleaning.....17, 18

Preventive Maintenance..... 19

Draining the Water Heater..... 20-22

Freeze Protection 22

Vacation and Extended Shutdown 23

Troubleshooting Chart..... 23, 24

Service Error Code Chart 25, 26

If You Need Service

Call for Assistance 26

Installation Instructions

Standards Compliance28

Choosing a Location 28, 29

Product Inspection..... 30

Water Heater Installation.....30-33

Venting.....34-45

Water Quality/Supply46-50

Gas Supply.....50-55

Electrical Wiring.....55-59

Remote Control Installation 58, 59

Insulation Blankets and Installation Precautions60

Installation Checklist.....61

Piping for Space Heaters62

Recirculation Control 63-65

Activating the Water Heater66

Operating Instructions67

Setting the Water Temperature 68-70

High-Altitude Dip Switch Adjustments.....70, 71

Water Saving Control Option72, 73

Maintenance Notice Option.....74, 75

Parts Ordering76, 77

Warranty Information.....79, 80

IMPORTANT SAFETY INFORMATION

READ THE SAFETY INFORMATION

Your safety and the safety of others are very important. There are many important safety messages in this manual and on your appliance. Always read and obey all safety messages.



This is the safety alert symbol. Recognize this symbol as an indication of Important Safety Information! This symbol alerts you to potential hazards that can kill or hurt you and others.

All safety messages will follow the safety alert symbol and either the word "DANGER," "WARNING," "CAUTION," or "NOTICE."

These words mean:

▲ DANGER: An imminently hazardous situation that will result in death or serious injury.

▲ WARNING: A potentially hazardous situation that can result in death or serious injury and/or damage to property.

▲ CAUTION: A potentially hazardous situation that may result in minor or moderate injury.

NOTICE: Attention is called to observe a specified procedure or maintain a specific condition.

▲ WARNINGS:

- This water heater is not suitable for use in manufactured (mobile) homes!
- Improper installation, adjustment, alteration, service, or maintenance can cause death, personal injury, or property damage. Follow the instructions in this manual.

READ ALL INSTRUCTIONS BEFORE USING.

Be sure to read and understand the entire Use and Care Manual before attempting to install or operate this water heater. It may save you time and money. Pay particular attention to the Safety Instructions. Failure to follow these warnings could result in death or serious bodily injury. Should you have problems understanding the instructions in this manual, or have any questions, STOP and get help from a qualified service technician or the local gas utility.

▲ WARNING:

California Proposition 65

This product contains chemicals known to the state of California to cause cancer, birth defects, or other reproductive harm.

IMPORTANT SAFETY INFORMATION

Water Heater Venting Safety

⚠ DANGER:

- Failure to install and properly vent the water heater to the outdoors as outlined in the “Venting” section of the Installation Instructions in this manual will result in death from fire, explosion, or asphyxiation from carbon monoxide. **NEVER** operate this water heater unless it is properly vented and has an adequate air supply for proper operation.
- Be sure to inspect the vent terminal, the air intake, and the coaxial vent system on the water heater for proper installation at initial start-up and at least annually thereafter. Refer to the “Care and Cleaning” section of this manual for more information regarding coaxial vent system inspection.

⚠ WARNINGS:

- Gasoline and other flammable liquids, materials, and vapors (including paint thinners, solvents, and adhesives) are extremely dangerous. **DO NOT** handle, use, or store gasoline or other flammable or combustible materials anywhere in the vicinity of a water heater or any other appliance. Be sure to read and follow the labels on the water heater, as well as the warnings printed in this manual. Failure to do so can result in death, bodily injury, or property damage.
- Combustible construction refers to adjacent walls and ceilings and should not be confused with combustible or flammable products and materials. Combustible materials, such as clothing, cleaning materials, or flammable liquids, should never be stored in the vicinity of this or any gas appliance. Fire or explosion can occur causing death, personal injury, and/or product damage. See page 29 for clearances to combustible materials.
- Follow vent manufacturer’s instructions for venting installation, including additional clearances from combustibles, to avoid conditions that can lead to death, personal injury, and/or property damage.
- Use tankless water heater manufacturer-approved Category III Stainless Steel vent material only. No other vent material is permitted.
- Moisture in the flue gas will condense as it leaves the vent terminal. In cold weather this condensate can freeze on the exterior wall, under the eaves, and on surrounding objects. Some discoloration to the exterior of the building is to be expected. However, improper location or installation can result in severe damage to the structure or exterior finish of the building.



⚠ Vapors from flammable liquids will explode and catch fire causing death or severe burns.

Do not use or store flammable products such as gasoline, solvents or adhesives in the same room or area near the water heater.

Keep flammable products:

1. far away from heater,
2. in approved containers,
3. tightly closed and
4. out of children's reach.

Installation:

Do not install water heater where flammable products will be stored or used unless the main burner flame is at least

Water heater has a main burner flame.

The main burner flame:

1. which can come on at any time and
2. will ignite flammable vapors.

Vapors:

1. cannot be seen,
2. are heavier than air,
3. go a long way on the floor and
4. can be carried from other rooms to the main burner flame by air currents.

18" above the floor. This will reduce, but not eliminate, the risk of vapors being ignited by the main burner flame.

Read and follow water heater warnings and instructions. If owners manual is missing, contact the retailer or manufacturer.

- For multiple-unit installation, a minimum distance between vent terminations must be maintained to prevent recirculation of vent gases. Maintain a center-to-center distance between vent terminations of 19 in. (48 cm) for two-unit installation. Maintain a center-to-center distance between vent terminations of 21 in. (53 cm) for installation of three or more units.

⚠ CAUTIONS:

- Ensure that the appliance vent is securely attached to the water heater collar.
- Condensate must drain away from the water heater and should not be allowed to drain back into any part of the vent system.
- **DO NOT** operate without the condensate trap connected to the vent and routed to the proper drain.
- Follow the vent manufacturer’s installation instructions because the design might vary from manufacturer to manufacturer.

IMPORTANT SAFETY INFORMATION

Water Supply Safety

⚠️ DANGERS:

- **WATER TEMPERATURE SETTINGS** – Safety and energy conservation are factors to be considered when selecting the water temperature setting of a water heater's remote control. Water temperatures above 125°F (52°C) can cause death or severe burns from scalding. Be sure to read and follow the warnings outlined on the pictured label.
- There is a hot water scald potential if the water temperature is set too high. Households with small children, the disabled, or elderly persons may require a 120°F (49°C) or lower temperature setting to prevent contact with "HOT" water.
- Before manually operating the relief valve, make certain no one will be exposed to the danger of the hot water released by the valve. The water may be hot enough to create a scald hazard. The water should be released into a suitable drain to prevent injury or property damage.
- Failure to perform the recommended Routine Preventive Maintenance can harm the proper operation of this water heater, which can cause carbon monoxide dangers, excessive hot water temperatures, and other potentially hazardous conditions.

⚠️ WARNINGS:

- **IMPORTANT: DO NOT** apply heat to the HOT or COLD water connections. If sweat connections are used, sweat tubing to adapter before fitting adapter to the water connections on heater. Any heat applied to the water supply fittings will permanently damage the internal components of the water heater.
- In case the pipe insulation is not rated for the appropriate weather conditions, install electric heat tracing or equivalent to prevent freezing of the pipes. **DO NOT** insulate or block the drain valve on the hot outlet fitting. If the pipes are allowed to freeze, the water heater and the pipes may malfunction or leak due to freezing water.
- Failure to drain the water heater as described on page 20 can cause serious personal injuries from scalding and/or damage the water heater.

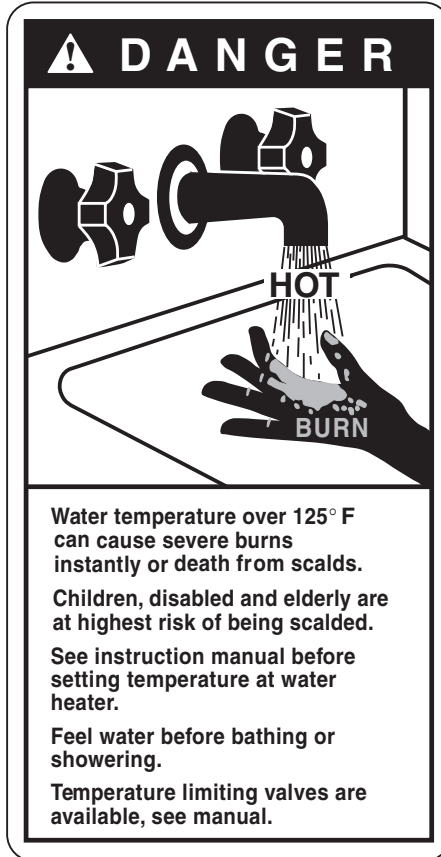

⚠️ CAUTIONS:

- This water heater must only be used with the following water supply system conditions:
 - With clean, potable water free of corrosive chemicals, sand, dirt, or other contaminants.
 - With inlet water temperatures above 32°F (0°C), but not exceeding 120°F (49°C).
 - **DO NOT** reverse the hot and cold water connections. The water heater will not operate.
- Even when drained properly, a small amount of water will remain in the water heater. In cold weather conditions, this water can freeze. If this happens, allow the defrost protection on the heater at least 30 minutes to melt the frozen water or the water heater may not work properly.

Time/Temperature Relationship in Scalds

| Water Temperature | Time to Produce a Serious Burn |
|-------------------|--------------------------------|
| 120°F (49°C) | More than 5 minutes |
| 125°F (52°C) | 1 1/2 to 2 minutes |
| 130°F (54°C) | About 30 seconds |
| 135°F (57°C) | About 10 seconds |
| 140°F (60°C) | Less than 5 seconds |
| 145°F (63°C) | Less than 3 seconds |
| 150°F (66°C) | About 1 1/2 seconds |
| 155°F (68°C) | About 1 second |

Table courtesy of Shriners Burn Institute

| | | | | | | | | |
|-----|-----|-----|-----|-----|-----|-----|-----|----|
| 85 | 100 | 102 | 104 | 106 | 108 | 110 | 112 | °F |
| 29 | 38 | 39 | 40 | 41 | 42 | 43 | 44 | °C |
| 114 | 116 | 118 | 120 | 125 | 130 | 140 | | °F |
| 46 | 47 | 48 | 49 | 52 | 54 | 60 | | °C |

IMPORTANT SAFETY INFORMATION

Natural Gas and Liquefied Petroleum Safety

⚠ DANGERS:

- Never attempt to convert the water heater from natural gas to LP. The water heater should only use the fuel type in accordance with listing on data plate—natural gas for natural gas units and LP for LP units. Any other fuel usage will result in death or serious personal injury from fire and/or explosion. This water heater is not certified for any other fuel type.
- Both natural gas and propane (LP) have an odorant added to aid in detecting a gas leak. Some people may not physically be able to smell or recognize this odorant. If you are unsure or unfamiliar with the smell of natural gas or LP, ask the gas supplier. Other conditions, such as “odorant fade,” which causes the odorant to diminish in intensity, can also hide or camouflage a gas leak.
- Water heaters using LP gas are different from natural gas models. A natural gas water heater will not function safely on LP and vice versa.
- LP water heaters should not be installed below grade (for example, in a basement) if such installation is prohibited by federal, state, and/or local laws, rules, regulations, or customs.
- LP must be used with great caution. It is heavier than air and will collect first in lower areas, making it hard to detect at nose level.
- Before attempting to light the water heater, make sure to look and smell for gas leaks. Use a soapy solution to check all gas fittings and connections. Bubbling at a connection indicates a leak that must be corrected. When smelling to detect a gas leak, be sure to also sniff near the floor.
- Gas detectors are recommended in LP and natural gas applications and their installation should be in accordance with the detector manufacturer’s recommendations and/or local laws, rules, regulations, or customs.
- Combustible materials, such as clothing, cleaning materials, or flammable liquids, must not be placed in the vicinity of the water heater.
- If a gas leak is present or suspected:
 - DO NOT attempt to find the cause yourself.
 - Never use an open flame to test for gas leaks. The gas can ignite resulting in death, personal injury, or property damage.
 - Follow the steps listed under “What to Do If You Smell Gas” found on the front cover of this manual.

⚠ WARNINGS:

- The installation of gas piping must conform to local utility company requirements and/or in the absence of local codes, use the latest edition of National Fuel Gas Code (NFGC), ANSI Z223.1/ NFPA 54, or CAN/CSA B149.1, Natural Gas and Propane Installation Code.
- If inlet gas pressure is out of allowable range [4.0” w.c. (1.0kPa) – 10.5” w.c. (2.6kPa)] for Natural Gas, or [8.0” w.c. (2.0kPa) – 13.0” w.c. (3.2kPa)] for LP gas, a gas pressure regulator must be installed to maintain the allowable inlet gas pressure.
- Should overheating occur or the gas supply fail to shut off, turn off the manual gas control valve to the water heater.

⚠ CAUTIONS:

- DO NOT attempt repair of electrical wiring, gas piping, remote control, burners, vent connectors, or other safety devices. Refer repairs to qualified service personnel.
- Turn off the manual gas shut-off valve if the water heater has been subjected to overheating, fire, flood, physical damage, or if the gas supply fails to shut off.
- DO NOT turn on the water heater unless the water and gas supplies are completely opened.

NOTICE:

- The factory setting allows operating temperatures between 100°F (38°C) and 120°F (49°C). Temperatures of 85°F (29°C) and up to 140°F (60°C) can be achieved with the MAIN (UMC-117) remote control. Temperatures of 85°F (29°C) can be achieved with the Bath (USC-117 or USC2-117) remote control. Only qualified service personnel should perform this adjustment. Only factory-authorized remote control(s) should be used.

IMPORTANT SAFETY INFORMATION



Before operating this water heater, be sure to read and follow the instructions on the label pictured below and all other labels on the water heater, as well as the warnings printed in this manual. Failure to do so can result in unsafe operation of the water heater, resulting in death, personal injury, or property damage. Should you have any problems reading or following the instructions in this manual, STOP and get help from a qualified service technician.

FOR YOUR SAFETY READ BEFORE OPERATING

WARNING : If you do not follow these instructions exactly, a fire or explosion may result causing property damage, personal injury or loss of life.

- A. This appliance does not have a pilot. It is equipped with an ignition device which automatically lights the burner. Do not try to light the burner by hand.
- B. BEFORE OPERATING smell all around the appliance area for gas. Be sure to smell next to the floor because some gas is heavier than air and will settle on the floor.
WHAT TO DO IF YOU SMELL GAS
 - Do not try to light any appliance.
 - Do not touch any electric switch; do not use any phone in your building.
 - Immediately call your gas supplier from a neighbor's phone. Follow the gas supplier's instructions.
 - If you cannot reach your gas supplier, call the fire department.
 - Do not return to your home until authorized by the gas supplier or fire department.
- C. Use only your hand to push in or turn the gas control knob. Never use tools. If the knob will not push in or turn by hand, don't try to repair it, call a qualified service technician. Force or attempted repair may result in a fire or explosion.
- D. Do not use this appliance if any part has been under water. Immediately call a qualified service technician to inspect the appliance and to replace any part of the control system and any gas control which has been under water.

OPERATING INSTRUCTIONS

1. STOP! Read the safety information above on this label.
2. Turn off all electric power to the appliance.
3. Do not attempt to light the burner by hand.
4. Turn the Gas Shutoff Valve located on the outside of the unit clockwise  to the "OFF" position.
5. Wait five (5) minutes to clear out any gas. If you then smell gas, STOP! Follow "B" in the safety information above on this label. If you don't smell gas, go to the next step.
6. Turn the Gas Shutoff Valve located on the outside of the unit counterclockwise  to the "ON" position.
7. Turn on all electric power to the appliance.
8. If the appliance will not operate, follow the instructions "To Turn Off Gas To Appliance" and call your service technician or gas supplier.

GAS SHUTOFF VALVE



OPEN



CLOSE

TO TURN OFF GAS TO APPLIANCE

1. Turn off all electric power to the appliance if service is to be performed.
2. Turn the Gas Shutoff Valve located on the outside of the unit clockwise  to the "OFF" position.

IMPORTANT SAFETY INFORMATION

Electrical Safety

⚠ DANGER:

- Shock Hazard – Make sure the electrical power to the water heater is off to avoid electric shock that will result in death or serious personal injury.

⚠ WARNINGS:

- For your safety, the information in this manual must be followed to minimize the risk of fire, explosion, or electric shock that can result in death, personal injury, and/or property damage.
- Field wiring connections and electrical grounding must comply with local codes or, in the absence of local codes, with the latest edition of the National Electrical Code, ANSI/NFPA 70, or in Canada, Canadian Electrical Code, CAN/CSA C22.1, Part 1.

⚠ CAUTIONS:

- Label all wires prior to disconnecting for service. Wiring errors can cause dangerous and improper operation. Verify correct operation after servicing.
- For your safety, burner inspection and cleaning should be performed only by qualified service personnel.
- Make certain the power to the water heater is OFF before removing the unit cover panel. Exposed electrical components and moving parts can cause personal injuries.
- For your safety, DO NOT attempt repair of electrical wiring, gas piping, remote control, burners, vent connectors, or other safety devices. Refer repairs to qualified service personnel.

FOR INSTALLATIONS IN THE STATE OF CALIFORNIA

California law requires that water heaters must be braced, anchored, or strapped to resist falling or horizontal displacement due to earthquake motions. For water heaters up to 52-gallon capacity, a brochure with generic earthquake bracing instructions can be obtained from: Office of the State Architect, 1102 Q Street, Suite 5100, Sacramento, CA 95814, or you may call 916-445-8100 or ask a water heater dealer.

However, applicable local codes shall govern installation. For residential water heaters of a capacity greater than 52 gallons or tankless-style, consult the local building jurisdiction code for acceptable bracing procedures.

IMPORTANT SAFETY INFORMATION

General Installation and Maintenance Safety

⚠ WARNINGS:

- This water heater must be installed in accordance with these instructions, local codes, utility company requirements and/or in the absence of local codes, use the latest edition of the American National Standard/National Fuel Gas Code (NFGC), ANSI Z223.1 and National Fire Protection Association, NFPA 54, or in Canada, CAN/CSA B149.1, Natural Gas and Propane Installation Code, and the latest edition of the National Electrical Code, ANSI/NFPA 70, or in Canada, Canadian Electrical Code, CAN/CSA C22.1, Part 1.
- If local codes require the application of external insulation blanket kits, carefully follow the manufacturer's installation instructions included with the kit. Only use blanket kits that are approved for use with your water heater.
- For your safety, DO NOT attempt to disassemble this water heater for any reason. Improper adjustments, alterations, service, or maintenance can cause death, personal injury, or property damage.

SAFETY PRECAUTIONS:

- Read this manual entirely before installing and/or operating the water heater.
- Use this water heater only for its intended purpose as described in this Use and Care Manual.
- Have the installer show you the location of the gas shut-off valve and how to shut it off if necessary. Turn off the manual shut-off valve if the water heater has been subjected to overheating, fire, flood, physical damage, or if the gas supply fails to shut off.
- Be sure your water heater is properly installed in accordance with local codes and the provided installation instructions.
- DO NOT attempt to repair or replace any part of your water heater unless it is specifically recommended in this manual. All other servicing should be referred to a qualified service technician.

SAVE THESE INSTRUCTIONS

PRODUCT INFORMATION

For Your Records

Write down and save the following product information along with the original sales slip and/or cancelled check. The model and serial numbers can be found on the top label on the right side of the water heater.

| |
|---|
| MODEL NUMBER: |
| SERIAL NUMBER: |
| DATE OF INSTALLATION: |
| INSTALLING COMPANY/PHONE NUMBER: |
| PLUMBING CONTRACTOR/PHONE NUMBER: |
| See page 26 for additional service information. |

Read This Manual

Inside you will find many helpful hints on how to use and maintain your water heater properly. A little preventive care on your part can save you time and money over the life of your water heater.

You'll find many answers to common problems in the Troubleshooting Chart on pages 23 and 24. Always refer to this chart before calling for service. Referring to this chart before calling may answer your question(s) and eliminate the need for service.

Preoperating Checklist

- Is the main gas valve to the water heater turned on?
- Is the fuse in place or is the breaker turned on?
- Does the water heater's electronic ignition light?
- Is the water temperature set to a safe temperature?
- Is the water heater connected to a floor drain?
- Is the water heater properly vented to the outside?
- Is the water heater installed in a safe location away from flammable materials and/or freezing conditions?

PRODUCT INFORMATION

Specifications – Direct-Vent Models

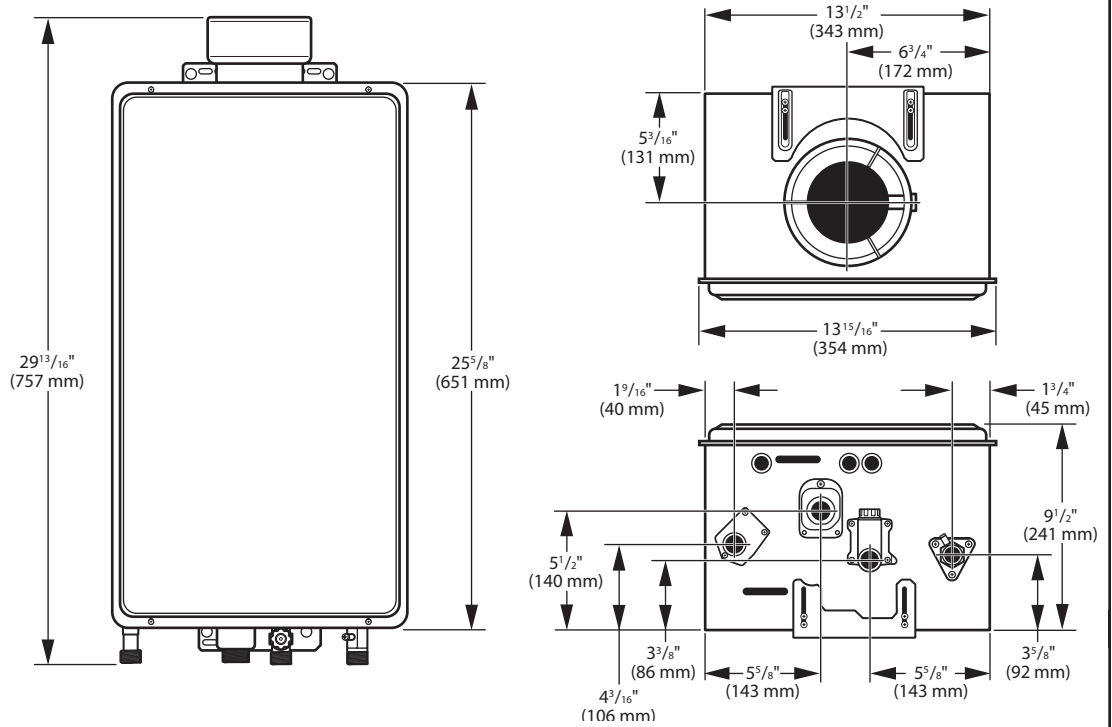

Specifications – Outdoor Models

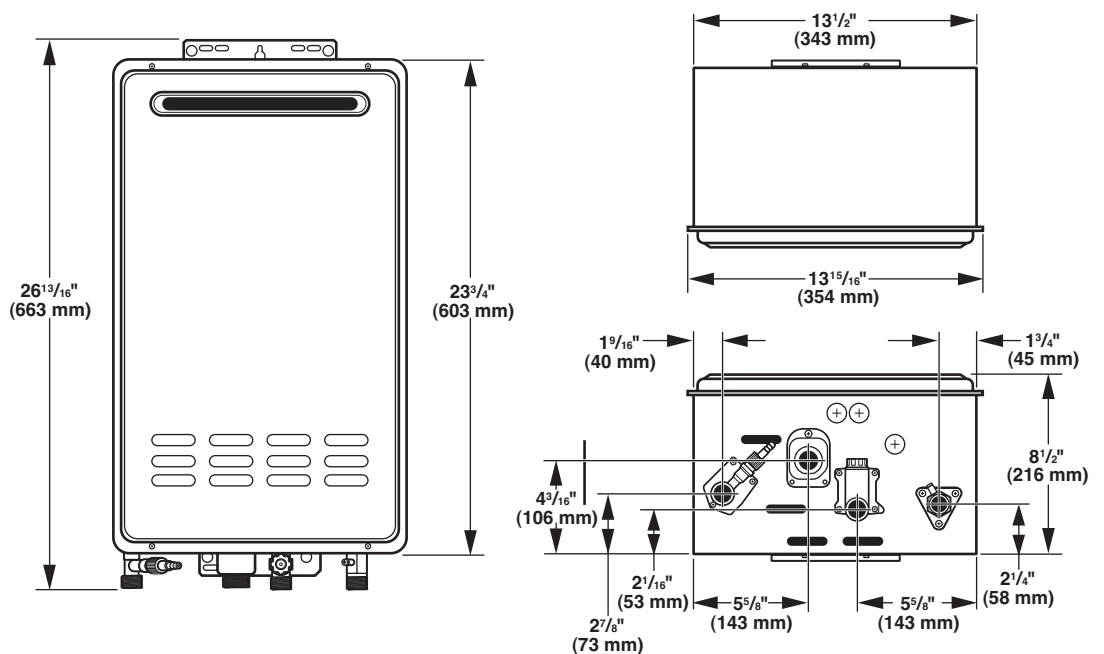

Product Information

PRODUCT INFORMATION

Specifications

The following product information can be found from the rating label on this water heater.

- A. Model Number
- B. Serial Number
- C. Data Bar Code
- D. Heater Type
- E. Installation Type
- F. Type of Gas
- G. Max. Inlet Gas Pressure
- H. Min. Inlet Gas Pressure
- J. Recovery Rating
- K. Max. BTU Input Rating
- L. Min. BTU Input Rating
- M. Manifold Gas Pressure
- N. Certification Stamp
- P. Alternate Approval Stamp
- Q. Clearances

English Rating Label

MODEL NO. SERIAL NUMBER **A B D**

XXXX AUTOMATIC INSTANTANEOUS WATER HEATER FOR ANSIZ21.10.30/CSA 4.3b-2008 INSTALLATION ONLY

E TYPE OF GAS: GAS

F MAX. INLET GAS PRESSURE: "w.c.

G MIN. INLET GAS PRESSURE: "w.c.

H RECOVERY RATING: J GALLONS/HR

I MAX. WORKING PRESSURE: 150 psi

J ELECTRICAL RATING: 120V 60HZ LESS THAN 2 AMPS

K MAX. INPUT: BTU/HR

L MIN. INPUT: BTU/HR

M MANIFOLD PRESSURE: "w.c. (FOR MAX. INPUT)

C

P

N

This appliance must be installed in accordance with local codes or, in the absence of local codes, the National Fuel Gas Code, ANSI Z223.1/NFPA 54 or the CSA B149.1, Natural Gas and Propane Installation Code.

"Suitable for water (potable) heating and space heating." The water heater shall not be connected to any heating system or component(s) previously used with a nonpotable water heating appliance. A pressure relief valve listed as complying with the Standard for Relief Valves and Automatic Gas Shutoff Devices for Hot Water Supply Systems, ANSI Z21.22 shall be installed at the hot water outlet connection of the water heater at the time of installation of the heater. Local codes shall govern the installation of relief devices. For safe operation of the water heater, the relief valve(s) must not be removed or plugged. No valve shall be placed between the relief valve and the water heater. The relief from the discharge of the pressure relief valve shall be disposed of in a suitable place where it will cause no damage. Also there shall be no other reducing coupling or other restrictions installed on the discharge line to restrict flow. See Installation Manual Heading.

"PRESSURE RELIEF VALVES" for installation and maintenance of relief valve discharge line and other safety precautions: Turn off the electrical power and gas shutoff valve. Lift and release lever on the relief valve and check the manual operation of relief valve at least once a year. Make certain the discharged water is directed to a suitable drain. Avoid contact with hot water and prevent water damage.

Q

MINIMUM CLEARANCE FROM COMBUSTIBLE OR NONCOMBUSTIBLE CONSTRUCTION: 1/2" SIDE CLEARANCE FROM FLANGED ENDS TO WALL; 0" REAR CLEARANCE FROM MOUNTING BRACKET TO WALL; 12" TOP CLEARANCE FROM TOP OF HEATER TO CEILING; 12" BOTTOM CLEARANCE FROM BOTTOM OF HEATER TO FLOOR; 12" FRONT CLEARANCE FROM FRONT OF HEATER TO CLOSET DOOR. *NOTE: 24" MINIMUM RECOMMENDED FRONT CLEARANCE FOR SERVICE AND MAINTENANCE. WIRING DIAGRAM BEHIND THE FRONT COVER.

FOR YOUR SAFETY - DO NOT STORE OR USE GASOLINE OR OTHER FLAMMABLE VAPORS AND LIQUIDS IN THE VICINITY OF THIS OR ANY OTHER APPLIANCE.

English/French Rating Label

MODEL NO. NUMÉRO DE MODÈLE **A B**

XXXX AUTOMATIC INSTANTANEOUS WATER HEATER CHAUFFE-EAU INSTANTANÉ AUTOMATIQUE POUR USAGE À

E INSTALLATION ONLY UNIFORMEMENT

F TYPE OF GAS: GAZ

G MAXIMUM INLET GAS PRESSURE: "w.c. PO. C.E.

H MINIMUM INLET GAS PRESSURE: "w.c. PO. C.E.

J RECOVERY RATING: J GALLONS/HR

I MAXIMUM WORKING PRESSURE: 150 psi

J TAUX DE RÉCUPÉRATION: J GALLONS/HR

K MAXIMUM INPUT: BTU/HR

L MINIMUM INPUT: BTU/HR

M MANIFOLD PRESSURE: "w.c. (FOR MAXIMUM INPUT) PO. C.E. (POUR ENTREE MAXIMALE)

C

P

N

This appliance must be installed in accordance with local codes or, in the absence of local codes, the National Fuel Gas Code, ANSI Z223.1/NFPA 54 or the CSA B149.1, Natural Gas and Propane Installation Code.

Cet appareil doit être installé conformément aux codes locaux ou, en l'absence de codes locaux, selon le code national du gaz, ANSI Z223.1/NFPA 54 ou la norme CSA B149.1, Code d'installation pour gaz naturel et propane.

LE SCHEMA DE CÂBLAGE SE TROUVE DERRIÈRE CE COUVERCLE.

FOR YOUR SAFETY - DO NOT STORE OR USE GASOLINE OR OTHER FLAMMABLE VAPORS AND LIQUIDS IN THE VICINITY OF THIS OR ANY OTHER APPLIANCE.

POUR VOTRE SÉCURITÉ, NE PAS CONSERVER OU UTILISER D'ÉSSENCE OU LIQUIDES INFLAMMABLES AUX ABORDS DE CET APPAREIL, OU DE TOUT AUTRE.

Q

MINIMUM CLEARANCE FROM COMBUSTIBLE OR NONCOMBUSTIBLE CONSTRUCTION: 1/2" SIDE CLEARANCE FROM FLANGED ENDS TO WALL; 0" REAR CLEARANCE FROM MOUNTING BRACKET TO WALL; 12" TOP CLEARANCE FROM TOP OF HEATER TO CEILING; 12" BOTTOM CLEARANCE FROM BOTTOM OF HEATER TO FLOOR; 12" FRONT CLEARANCE FROM FRONT OF HEATER TO CLOSET DOOR. *NOTE: 24" MINIMUM RECOMMENDED FRONT CLEARANCE FOR SERVICE AND MAINTENANCE. WIRING DIAGRAM BEHIND THE FRONT COVER.

Product Information

General Descriptions

Typical Direct-Vent Water Heater (Venting Required)

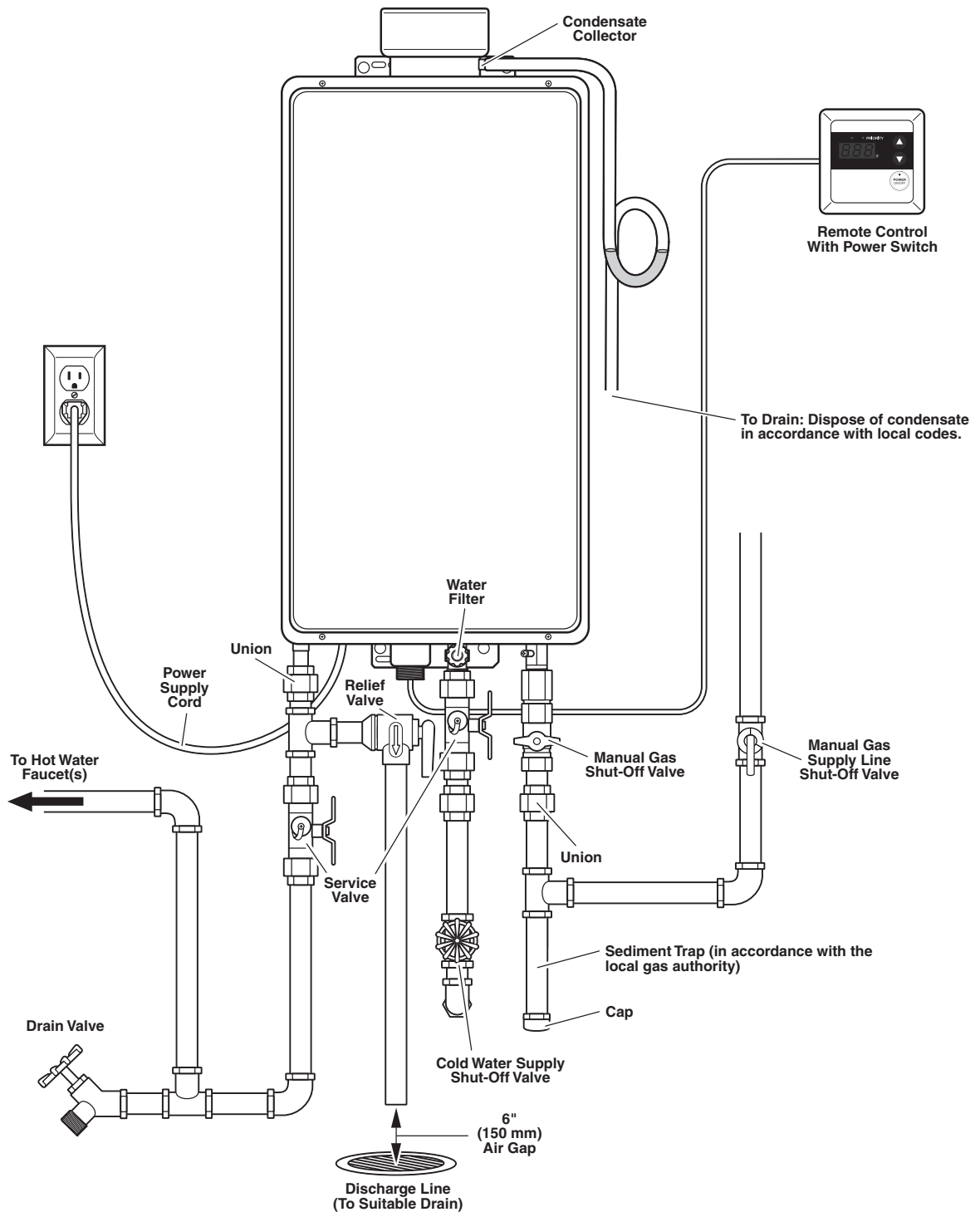

PRODUCT INFORMATION

Typical Outdoor Water Heater (No Venting Required)

This water heater is for OUTDOOR installation only.

⚠ DANGER:

DO NOT install this water heater indoors or in a confined area. It is designed for outdoor installation only. Any other type of installation will result in death or serious personal injury.

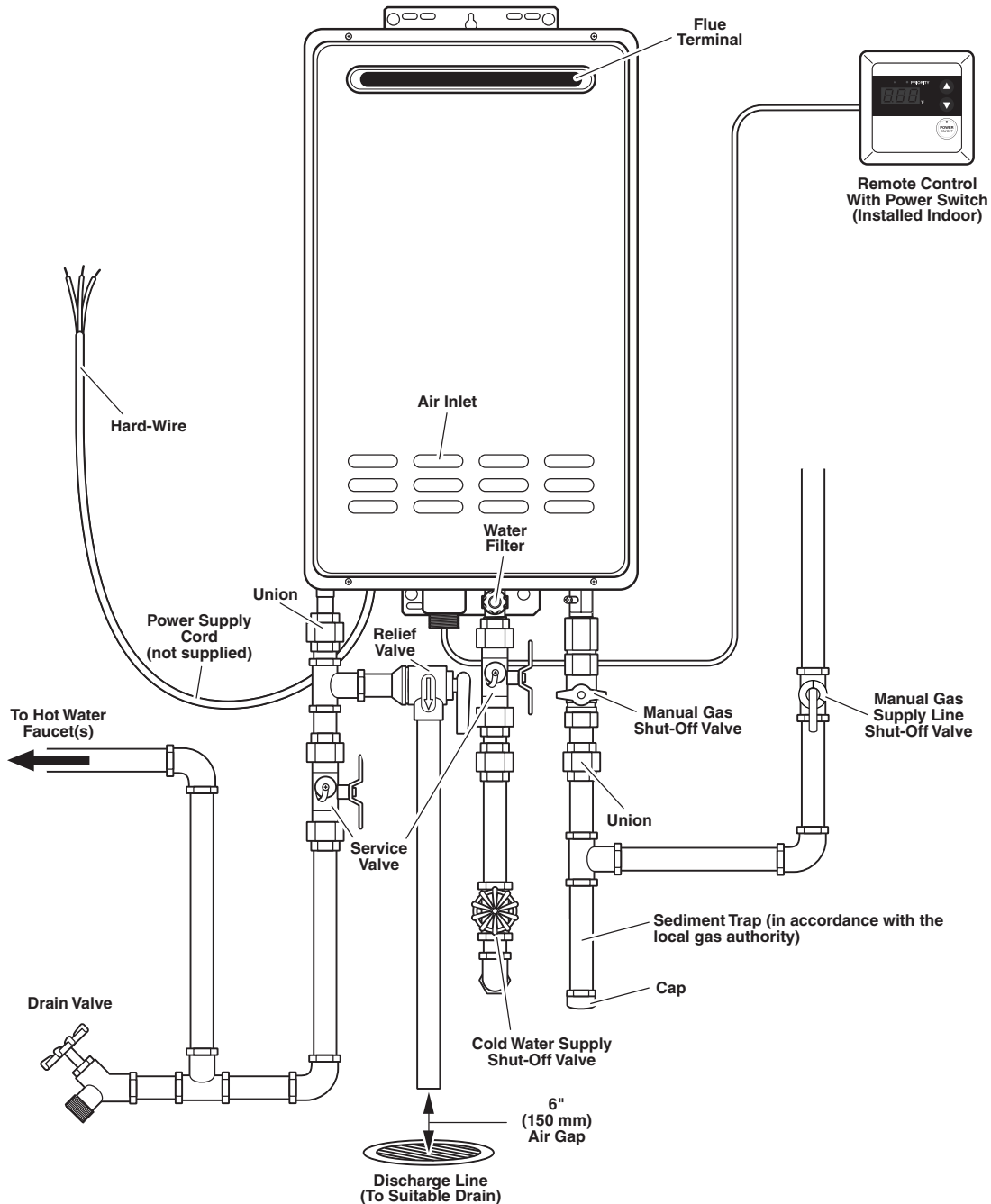

USING YOUR WATER HEATER



Safety Precautions

⚠️ WARNING:

- Flammable vapors can be drawn by air currents from surrounding areas to the water heater. Vapors can ignite causing death, personal injury, or product damage.
- **DO NOT** store or use flammable or combustible materials (gasoline, paint thinner, adhesives, newspapers, rags, mops, etc.) in the vicinity of the water heater or any other gas appliance. If they must be used, open doors and windows for ventilation, and shut off all gas-burning appliances, including their pilot lights.
- **DO** turn off manual gas shut-off valve if water heater has been subjected to overheating, fire, flood, physical damage, or if the gas supply fails to shut off.
- **DO NOT** turn on water heater unless water and gas supplies are completely opened.
- If there is any difficulty in understanding or following the operating and care instructions in this manual, it is recommended that you contact a qualified service technician to perform the work.



Setting the Water Temperature

⚠️ DANGER:

Water temperatures above 125°F (52°C) will result in death and/or severe burns from scalding.

Safety and energy conservation are factors to be considered when selecting the water temperature setting. The temperature of the water in the water heater can be regulated by setting the temperature on the front of the remote control. Be sure to read and follow the warnings outlined on the pictured label.

The remote control has been preset and shipped at the recommended temperature setting.

Safety factors should be considered whenever altering the water temperature setting. The chart below may be used as a guide in determining the proper water temperature for your home.

Time/Temperature Relationship in Scalds

| Water Temperature | Time to Produce a Serious Burn |
|-------------------|--------------------------------|
| 120°F (49°C) | More than 5 minutes |
| 125°F (52°C) | 1 1/2 to 2 minutes |
| 130°F (54°C) | About 30 seconds |
| 135°F (57°C) | About 10 seconds |
| 140°F (60°C) | Less than 5 seconds |
| 145°F (63°C) | Less than 3 seconds |
| 150°F (66°C) | About 1 1/2 seconds |
| 155°F (68°C) | About 1 second |

Table courtesy of Shriners Burn Institute

⚠️ DANGER

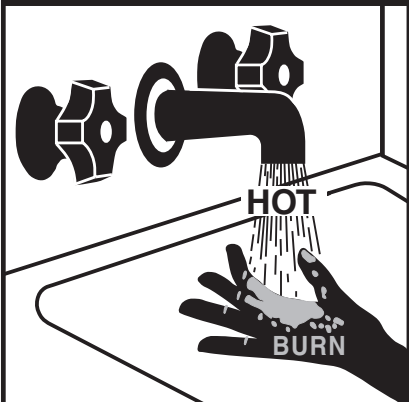

Water temperature over 125° F can cause severe burns instantly or death from scalds. Children, disabled and elderly are at highest risk of being scalded. See instruction manual before setting temperature at water heater. Feel water before bathing or showering. Temperature limiting valves are available, see manual.

Use Instructions

USING YOUR WATER HEATER



Setting the Water Temperature (cont.)

Maximum water temperature occurs while the water heater burner is on. To determine the water temperature:

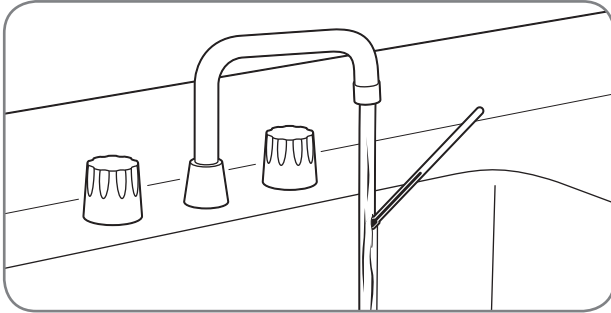

Turn on the hot water faucet and place a thermometer in the water stream.

NOTICE:

Water temperature at the faucet may vary depending on the season and the length of pipe from the water heater.

The remote control temperature range is between 100°F (38°C) and 120°F (49°C). To adjust the temperature to a desired setting, press the UP or DOWN adjustment button on the face of the remote control. The new temperature set point will show on the LED display.

NOTICE:

The temperature set point on the standard remote control cannot be increased above 112°F (44°C) when a hot water faucet is in the open position. To achieve temperatures above 120°F (49°C) or below 85°F (29°C), contact a qualified service technician. Only factory-authorized remote control(s) should be used.

The water heater may not operate with a small water flow. Increase the water flow and recheck. If it still does not operate with the hot water faucet completely open, increase the temperature setting on the remote control.

Water Heater Facts

⚠ DANGER:

Water temperatures above 125°F (52°C) will result in death and/or severe burns from scalding.

- The hottest-temperature water will be at the faucet closest to the water heater.
- Always remember to test the water temperature with your hand before use.
- Always supervise young children or others who are incapacitated.
- The water heater is equipped with a device that will shut off the gas supply to the burner if the water heater exceeds normal operating temperatures.
- Any water heater that has been subjected to fire, flood, physical damage, or been under water should be turned off at the manual gas shut-off valve and not used until it has been checked by qualified service personnel.

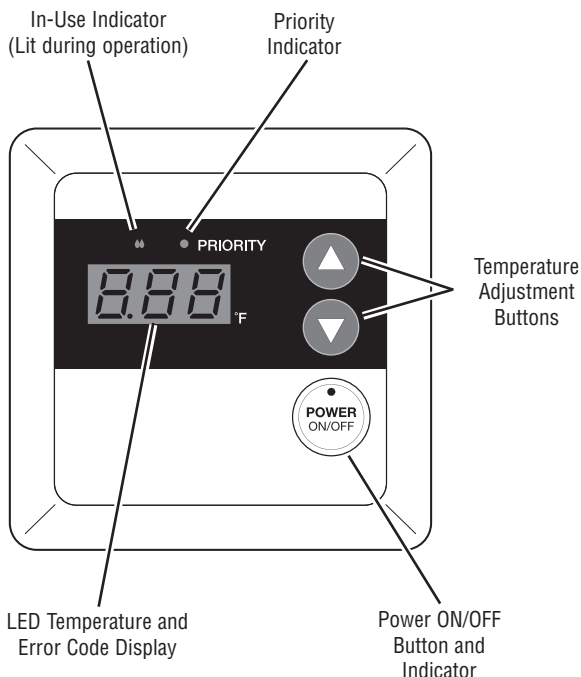

CARING FOR YOUR WATER HEATER



Water Heater Inspections

Venting System (Direct Vent Only)

The venting system should be inspected annually by a qualified service technician to ensure all of the vent sections are secure and airtight.

⚠ WARNING:

DO NOT operate the water heater if the vent system shows signs of leaking exhaust. Leaking exhaust could lead to death, personal injury, and/or product failure.

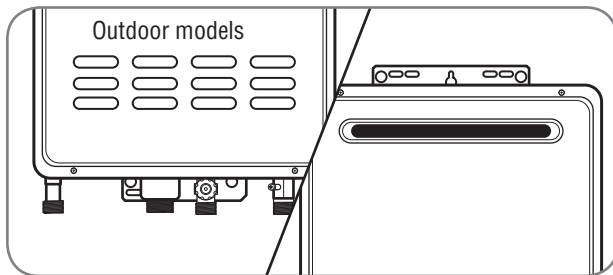

Check the air intake and vent outlet for blockage and/or debris.

Condensate Trap (Direct Vent Only)

⚠ CAUTION:

DO NOT operate without the condensate trap connected to the vent and routed to the proper drain. It could cause the system to malfunction or fail.

On a regular basis, inspect the condensate trap to ensure there is enough water in the trap and the condensate is draining properly.

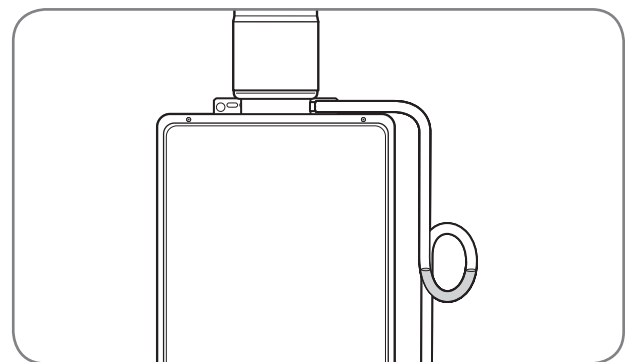

Ensure that condensate is disposed of per local codes and regulations.

CARING FOR YOUR WATER HEATER



Water Heater Inspections (cont.)

Burner

It is recommended that the burner be inspected annually by a qualified service technician.

⚠ DANGER:

Shock Hazard – Removing the front cover panel exposes you to live electricity. Electric shock will cause death or serious personal injury.

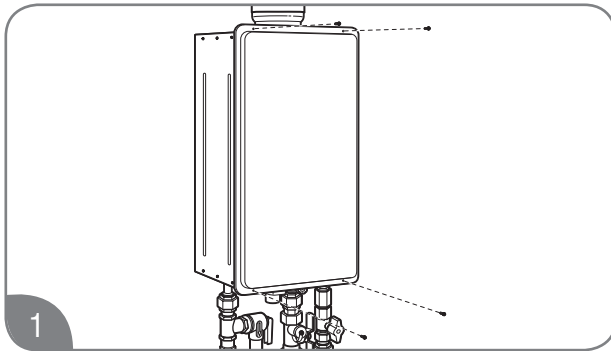

Remove 4 screws and the unit cover panel.

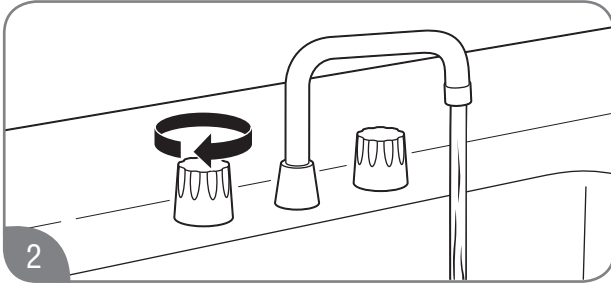

Turn on a hot water faucet.

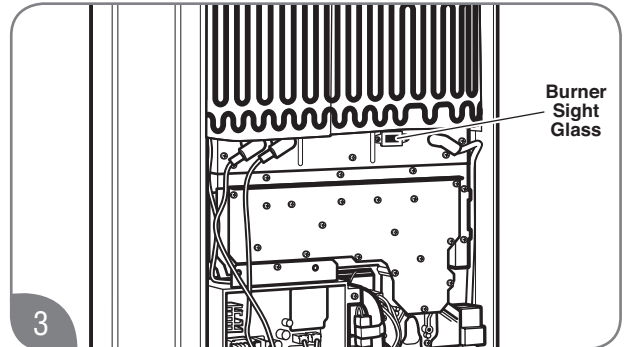

While the water heater is operating, inspect the main burner flames through the burner sight glass. The flames should be blue when the main burner is firing.

NOTICE:

If the flames are not blue or you observe unusual burner operation, shut off the water heater and contact a qualified service technician.

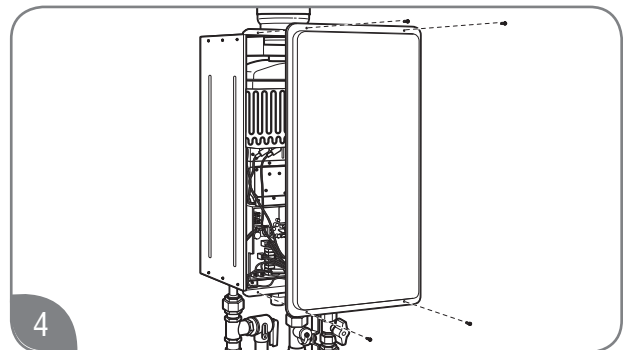

Turn off the hot water faucet and reinstall the unit cover panel.

CARING FOR YOUR WATER HEATER



Care and Cleaning

⚠ DANGER:

Shock Hazard – Make certain power to the water heater is OFF before removing protective cover for any reason. Electric shock will cause death or serious personal injury.

⚠ WARNING:

Combustible materials, such as clothing, cleaning materials, or flammable liquids, must not be placed against or next to the water heater. Fire or explosion can occur causing death, personal injury, and/or product damage.

All care and cleaning to and around the water heater should only be performed with the water heater turned off and the electrical power supply disconnected.

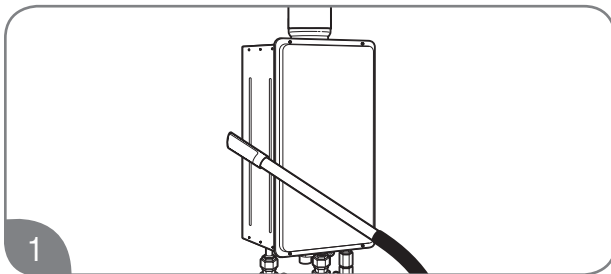

Vacuum around the water heater to remove any dust, dirt, and/or lint buildup.

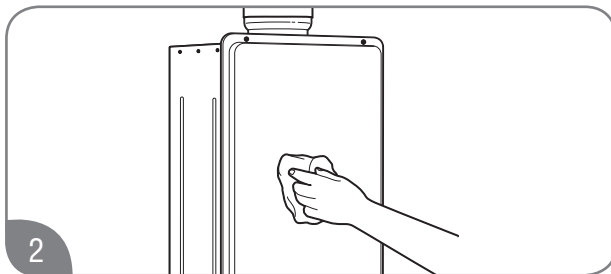

Clean the water heater and the remote control with a damp soft cloth and mild detergent. Gently wipe and completely dry all surfaces.

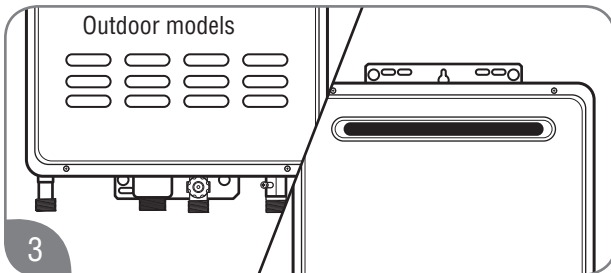

Check the air intake and vent outlet for blockage and/or debris.

NOTICE:

The air intake requires a minimum of 12 in. (30 cm) of clearance between the air intake opening and any obstruction.

Clean the water filter monthly, as described below and on page 18.

Water Filter Cleaning

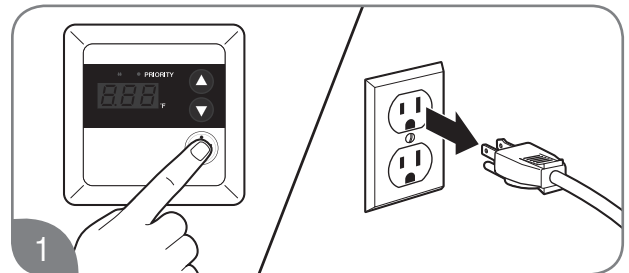

Turn off the water heater and disconnect the electrical power supply.

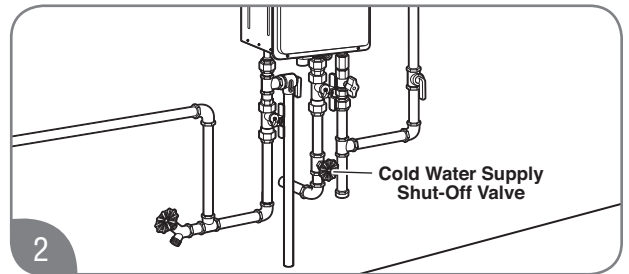

Turn off the water supply to the water heater.

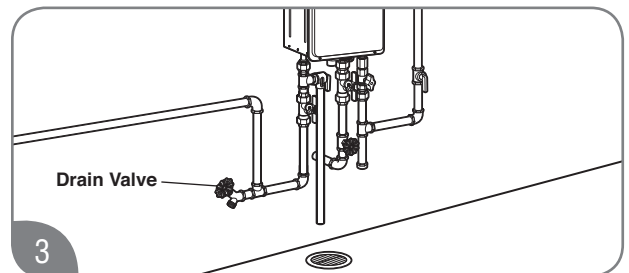

Drain the water heater. See page 20.

CARING FOR YOUR WATER HEATER



Care and Cleaning (cont.)

⚠ CAUTION:

DO NOT tap or force the filter during removal. This can deform and/or damage the filter.

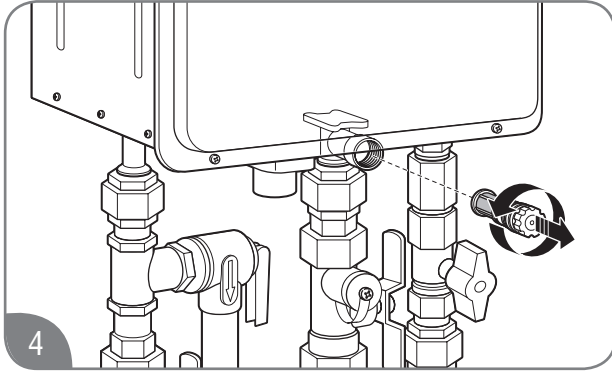

Unscrew the water filter from the base of the cold water inlet line and carefully slide it out of the line.

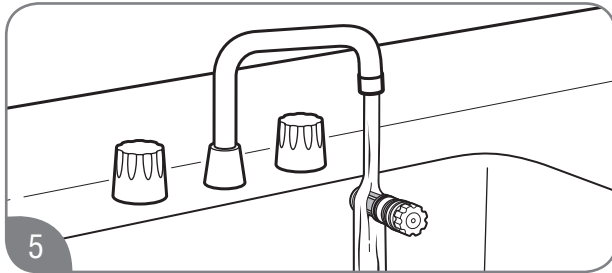

Clean the water filter under running water. To remove severe sediment and dirt, use a soft brush.

⚠ CAUTION:

DO NOT overtighten the water filter. Overtightening can deform and/or damage the filter.

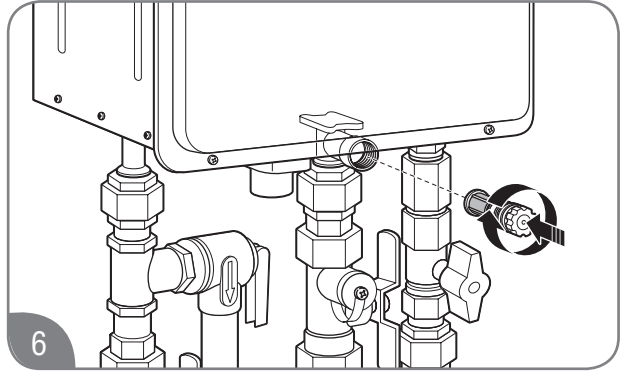

Replace the filter in the cold water inlet line and tighten until it is snug.

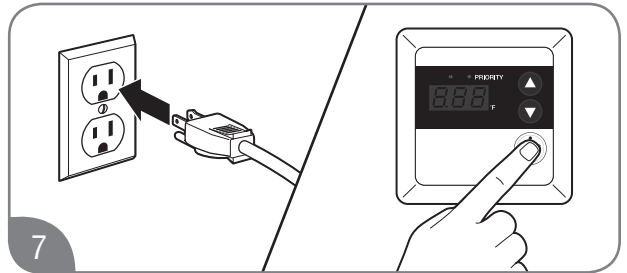

Turn on the water supply, reconnect the electrical supply, and turn on the water heater.

CARING FOR YOUR WATER HEATER



Preventive Maintenance

⚠️ WARNING:

Failure to perform routine preventive maintenance can prevent the water heater from operating properly. Improper operation can cause carbon monoxide dangers, excessive water temperatures, and other potentially hazardous conditions resulting in death, personal injury, and/or product damage.

Properly maintaining your water heater will ensure dependable, trouble-free service.

User Preventive Maintenance

Establish and follow a routine preventive maintenance program. The following suggested items should be included in your program.



Monthly check and clean the water filter. See “Water Filter Cleaning” on page 17.

⚠️ WARNING:

Hot water is released during manual operation of the relief valve. Make sure all people and animals are clear from the area before performing this check to prevent death, personal injury, and/or property damage from hot drain water.

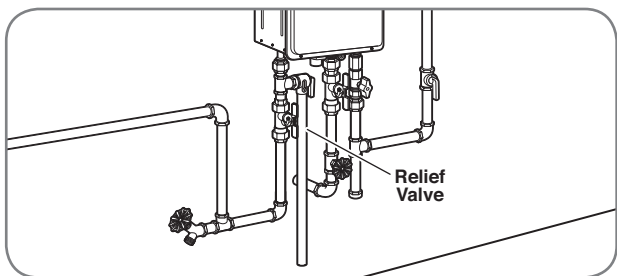

Annually check the operation of the pressure-relief valve. Lifting the lever handle on the pressure-relief valve opens the valve to flush hot water through the discharge line to the drain. After several gallons have drained, release the lever handle to close the valve and stop draining.

NOTICE:

If the pressure relief valve on the hot water heater discharges periodically, this may indicate a problem in the water system. Contact the water supplier or a plumbing contractor to correct the problem. **DO NOT** plug the relief valve outlet.

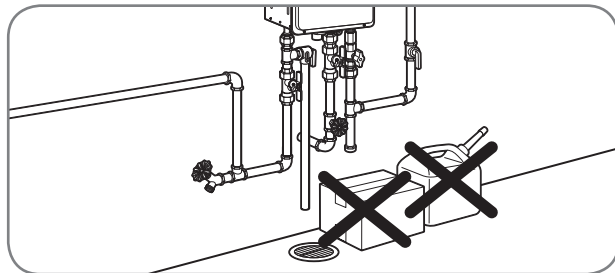

- Inspect and keep the area around the water heater clear and free of flammable materials, such as gasoline and other flammable vapors and liquids.
- Visually inspect the water heater for damage and/or denting. If present, contact a service personnel to verify proper operation.
- Check for abnormal sound during normal operation (e.g., hissing or banging noises). Contact a qualified service technician or plumbing contractor.
- Check all gas and water pipes for leaks. See page 54.

NOTICE:

- **DO NOT** operate the water heater if you feel something is wrong with the unit.
- **DO NOT** allow children to operate or handle the unit.
- After inspections, maintenance, and/or cleaning, ensure proper operation by turning on a hot water faucet.

Professional Preventive Maintenance

It is recommended that a periodic inspection of the water heater burner, relief valve, air intake filter, water filter, and venting system be made by a qualified service technician.

⚠️ WARNING:

Certain water conditions can damage the water heater and may cause defects, malfunctions or failures of the water heater that are not covered by the limited warranty. See page 46 for more detail.

CARING FOR YOUR WATER HEATER



Draining the Water Heater

⚠️ WARNING:

Failure to follow these draining instructions can cause serious personal injury from scalding and/or product damage.

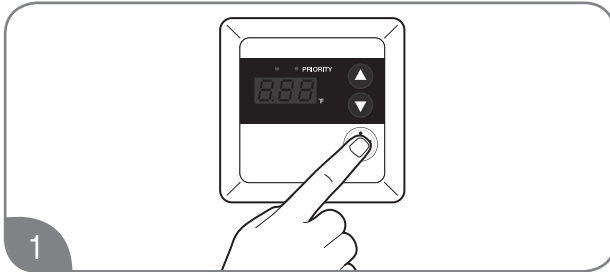

1 Turn off the water heater by pressing the POWER ON/OFF button on the control panel.

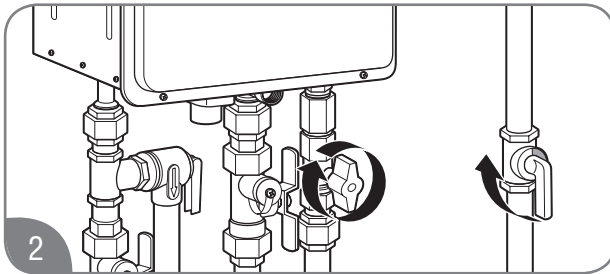

2 Close the gas shut-off valve(s).

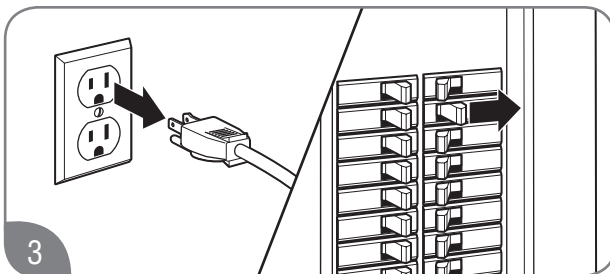

3 At least 10 seconds after Step 1, unplug the water heater or disconnect the power supply at the circuit breaker box.

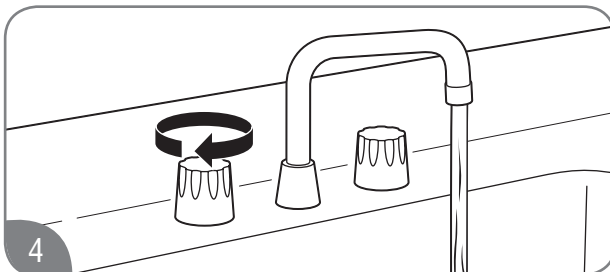

4 Open all hot water faucets. Run the water until it is COLD; then shut off the faucet.

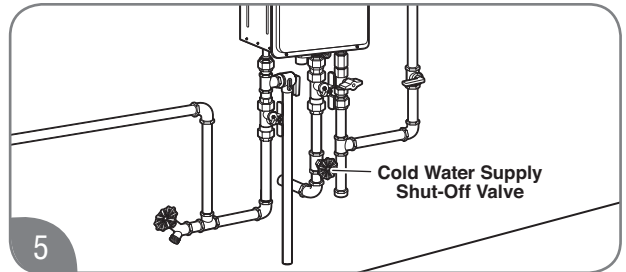

5 Close the water shut-off valve.

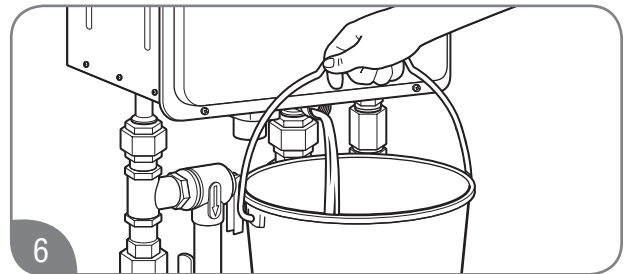

6 Using a suitable container to catch the water, remove the water filter from the base of the cold water inlet line.

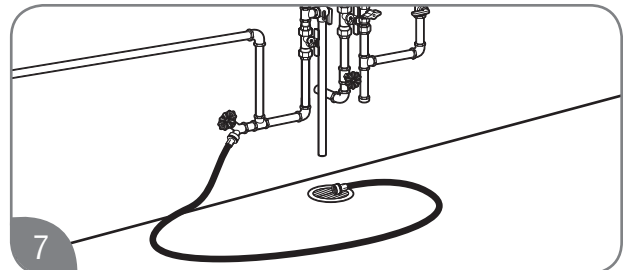

7 Connect a garden hose to the drain valve in the hot water outlet line and place the other end in a suitable drain. Open the drain valve until all the water has drained from the water heater. Leave water heater as is until placed back in service.

CARING FOR YOUR WATER HEATER



Draining the Water Heater (cont.)

⚠ CAUTION:

Even when drained properly, a small amount of water will remain in the water heater. In cold weather conditions, this water can freeze. If this happens, allow the defrost protection on the water heater at least 30 minutes to melt the frozen water. The water heater will not work properly until this water is thawed.

To put the water heater back in service:

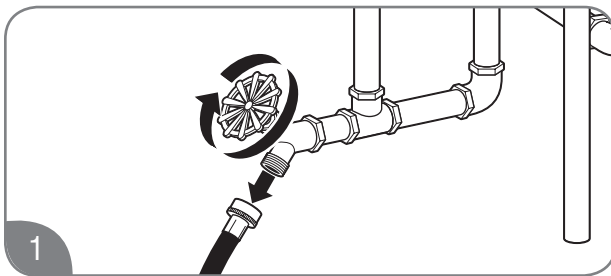

1
Disconnect drain hose. Make sure the drain valve is closed.

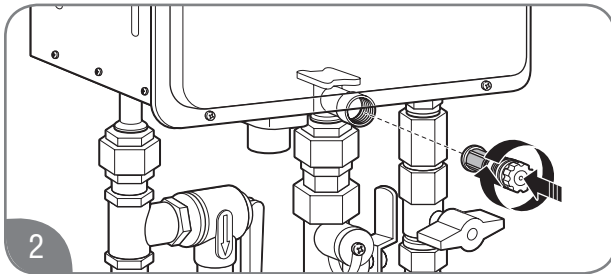

2
Reinstall the water filter in the base of the cold water inlet line.

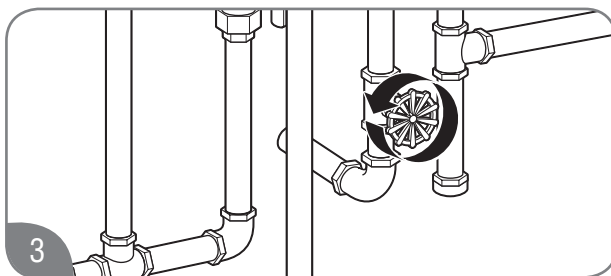

3
Open the water shut-off valve.

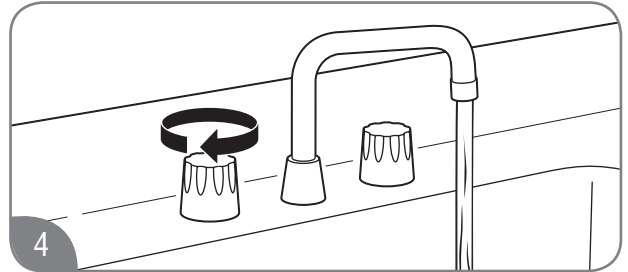

4
Open all hot water faucets and let run until all air has been purged from the lines.

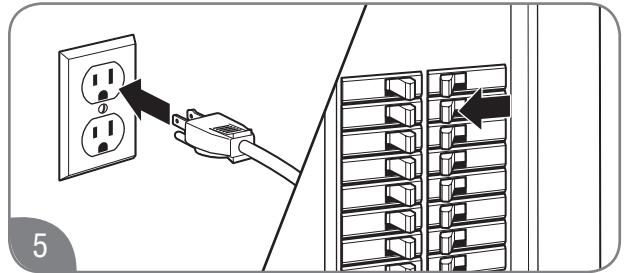

5
Plug in the power cord or reconnect the power supply at the circuit breaker box.

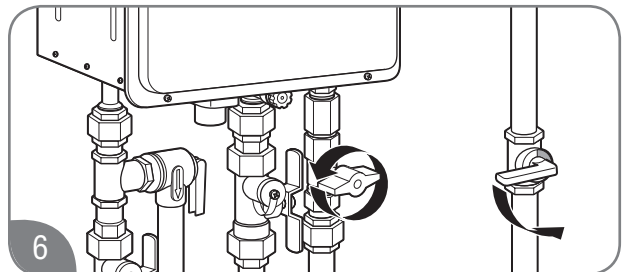

6
Open the gas shut-off valve(s).

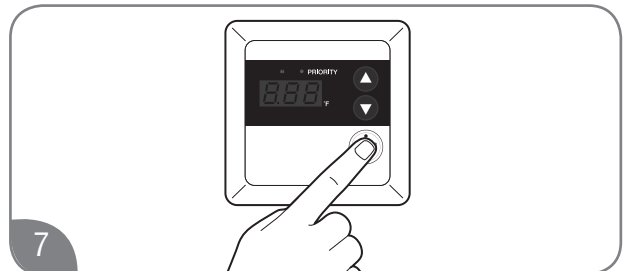

7
Press the POWER ON/OFF button on the control panel to restart the unit.

CARING FOR YOUR WATER HEATER



Draining the Water Heater (cont.)

Preferred Drain Method

Isolator valve kits may be purchased from the manufacturer, distributor, or place of purchase. The kits include two full port isolation valves to be used in the inlet and outlet water lines. It is highly recommended to install isolator valve kits because these kits provide a means for full diagnostic testing and ease of system flushing.

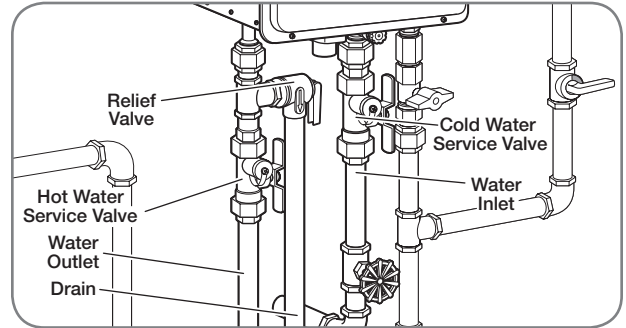

Freeze Protection

⚠ WARNING:

Failure to drain the water heater can cause serious personal injury from scalding and/or product damage.

Whenever the water heater may be exposed to freezing conditions, make sure to completely drain the water from the unit. See page 20.

Freezing conditions come from the ventilation system on direct-vent models and from exposure to cold air on outdoor models.

All of these water heaters are equipped with a freeze protection electric heater. This heater prevents freezing inside the water heater down to an ambient temperature of approximately -30°F (-34°C). These temperatures are all based on temperatures without wind.

The heater only protects the internal components of the water heater.

NOTICE:

Unplugging or disconnecting the power supply to the water heater will also disconnect the power to the heater.

External piping and valves require additional freeze protection. One method is to wrap insulation around the piping and valves.

Another method is to turn on a hot water faucet and leave a small amount of water running at a faucet. This will protect the water heater, piping, and valves from freezing.

Running Water Freeze Protection

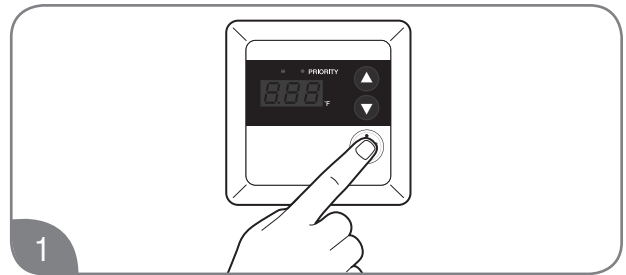

Turn off the water heater by pressing the POWER ON/OFF button on the control panel.

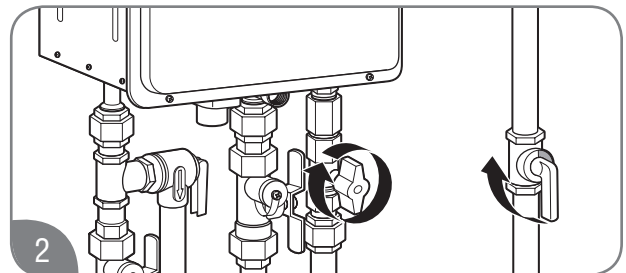

Close the gas shut-off valve(s).

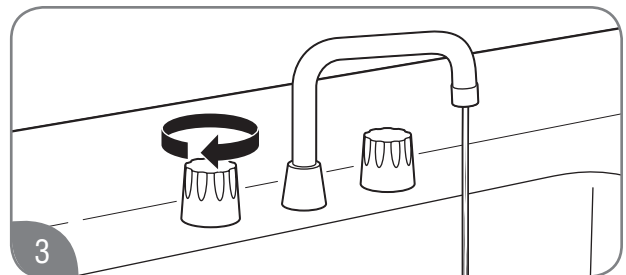

Open a hot water faucet slightly until the water stream is approximately 1/8 in. (0.3 cm). Be sure to check the flow periodically.

CARING FOR YOUR WATER HEATER



Vacation and Extended Shutdown

⚠️ WARNING:

Failure to drain the water heater can cause serious personal injury from scalding and/or product damage.

If the water heater is to remain idle for an extended period of time, the power and water to the heater should be turned off.

The water heater and piping should be drained if they might be subjected to freezing temperatures. See “Freeze Protection” section on page 22.

After an extended shutdown, the water heater’s operation and controls should be checked by a qualified service technician.



Troubleshooting Chart

The information in the following troubleshooting chart may help you diagnose and/or fix a problem you may be experiencing. Please review this chart before calling for service assistance.

⚠️ DANGER:

Shock Hazard – Make certain power to the water heater is OFF before removing protective cover for any reason. Electric shock will cause death or serious personal injury.

⚠️ WARNING:

For Your Safety, DO NOT attempt repair of electrical wiring, gas piping remote control, burners, vent connectors, or other safety devices. Refer repairs to a qualified service technician.

| Problem | Possible Cause | Solution |
|---------|--|---|
| | 1. Unit is not ON. | 1. Turn on the unit by pressing the POWER ON/OFF button. |
| | 2. Water shut-off valve is not completely opened. | 2. Check shut-off valve and open completely. |
| | 3. Hot water faucet is not completely opened. | 3. Open hot water faucet completely. (The main burner goes off when incoming water volume is inadequate.) |
| | 4. Water piping is frozen. | 4. Allow piping to thaw. |
| | 5. Electrical power is disconnected or water supply is shut off. | 5a. Plug in the power cord or reconnect the power supply at the circuit breaker box. 5b. Completely open the water supply valve. (Inadequate water volume will cause the main burner to turn off.) |
| | 6. The temperature may be set too low. | 6. Increase the temperature setting. |
| | 7. Mixing valve malfunctions (if applicable). | 7. Check and replace the mixing valve. |
| | 8. Error code displayed on the remote control. | 8. See “Service Error Code Chart” on page 25. If required, contact a qualified service technician. |
| | 9. Not enough water demand. | 9. Increase the hot water flow at the faucet. |
| | 10. Water filter is clogged or dirty. | 10. Clean the water filter. (See page 17.) |
| | 11. Fixture aerator is clogged or dirty. | 11. Clean the aerator. |
| | 12. Scale buildup in the heat exchanger. | 12. Check for error code. If required, contact a qualified service technician. |
| | 13. Hot and cold water lines reversed. | 13. Reverse the water lines. |

CARING FOR YOUR WATER HEATER



Troubleshooting Chart (cont.)

| Problem | Possible Cause | Solution |
|---|---|--|
| <p>Water not hot enough.</p> | 1. The temperature may be set too low. | 1. Increase the temperature setting at the remote control. |
| | 2. The gas valve is not completely opened. | 2. Check and completely open the gas valve. |
| | 3. Gas supply pressure is low. | 3. Contact your gas utility company or gas contractor to verify the gas meter and gas piping size. |
| | 4. Bleed-over in one of the hot water fixtures. | 4. Contact a dealer or a qualified service technician. |
| <p>Water too hot.</p> | 1. Temperature is set too high. | 1. Decrease the temperature setting at the remote control. |
| | 2. Water shut-off valve is not completely opened. | 2. Check and completely open the water shut-off valve. |
| | 3. Small amount of water has been heated. | 3. Increase the hot water flow at the faucet to allow more water to flow through the water heater. |
| Fan continues to rotate after the hot water faucet is closed. | The post-purge cycle clears flue gases. | Normal operation. |

CARING FOR YOUR WATER HEATER



Service Error Code Chart

Your water heater has an electronic diagnostic system built into it. When the water heater finds a problem, it displays an error code in the LED display on the remote control. The following chart lists the error codes along with their possible problem and solution. Using this chart may help you diagnose and/or fix a problem you may be experiencing. Please refer to this chart before calling for service assistance.

⚠ DANGER:

Shock Hazard – Make certain power to the water heater is OFF before removing protective cover for any reason. Electric shock will cause death or serious personal injury.

⚠ WARNING:

For Your Safety, DO NOT attempt repair of electrical wiring, gas piping, remote control, burners, vent connectors, or other safety devices. Refer repairs to a qualified service technician.

When an error code is displayed:

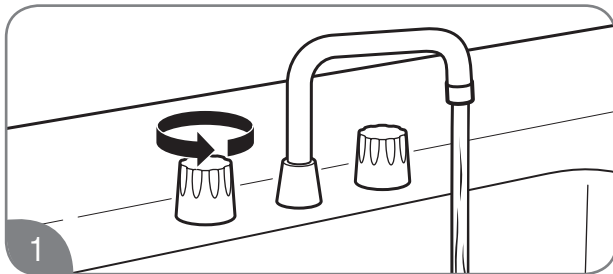

Turn off all the hot water faucets.

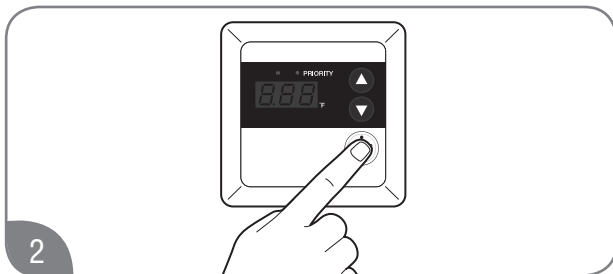

Turn off the water heater by pressing the POWER ON/OFF button on the remote control.

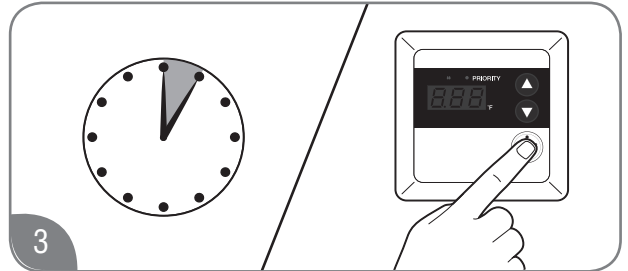

Wait about 5 minutes; then restart the water heater by pressing the POWER ON/OFF button.

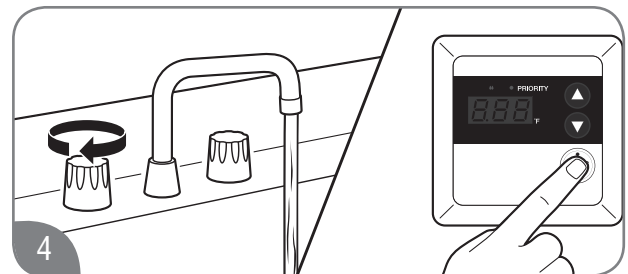

Turn on a hot water faucet and recheck the remote control display.

If the error code remains in the display:

1. Turn off the hot water faucet.
2. Turn off the water heater.
3. Unplug the water heater from power, wait about 30 seconds and plug back in.
4. Follow the error code chart information.
5. Restart the water heater, turn on a hot water faucet, and recheck the remote control display.

If the error code is still shown:

1. Turn off the hot water faucet.
2. Turn off the water heater.
3. Make note of the displayed error code and call for service assistance. See "Call for Assistance" section on page 26.

NOTICE:

If the displayed error code is not listed in the chart, immediately turn off the water heater and call for service assistance.

CARING FOR YOUR WATER HEATER



Service Error Code Chart (cont.)

| Error Code | Possible Cause | Solution |
|------------|--|---|
| 1L | Water heater has buildup of lime deposits. | Contact a dealer or qualified service technician. |
| 05 | Air intake or vent exhaust opening may be blocked. | Remove any blockage. (Air intake requires 12 in. [30 cm] of clearance.) |
| | The vent pipes on the vent termination may not be connected properly. | Contact a dealer or qualified service technician. |
| 11 | The gas shut-off valve is not fully opened. | Check shut-off valve and open completely. |
| 12 | Gas service has been interrupted. | Contact your gas utility company. |
| | LP gas is running low (LP models only). | Refill or replace your LP gas container. |
| 13 | If this code is still displayed after taking the numbered steps above. | Contact a dealer or qualified service technician. |
| 14 | Water heater is overheating. | Contact a dealer or qualified service technician. |
| 15 | The heat exchanger is too hot. | Check for blockage in the vent. Contact a dealer or qualified service technician. |
| 31 | Faulty inlet thermistor. | Contact a dealer or qualified service technician. |
| 33 | Faulty outlet thermistor. | Contact a dealer or qualified service technician. |
| 61 or 99 | Faulty blower motor. | Contact a dealer or qualified service technician. |
| 65 | Faulty water flow solenoid. | Contact a dealer or qualified service technician. |
| P1 | Not enough water flow to operate the unit. | Increase the water flow from the fixtures. |
| 88 | Reminder of flushing the heat exchanger and/or replacing the water treatment filter. | Contact a dealer or qualified service technician. |

IF YOU NEED SERVICE



Call for Assistance

1. All questions, adjustments, repairs, and/or routine maintenance should be directed to your installer, plumbing contractor, or licensed service agent. If your contacts have moved or are not available, please refer to the telephone directory, commercial listings, or local utility company for qualified service assistance.

2. If your problem has not been solved to your satisfaction, contact the Rheem National Service Department at the following address:

Rheem
National Service Department
1241 Carwood Court
Montgomery, Alabama 36117
Phone: 1-866-720-2076

When contacting the manufacturer, the following information will be requested:

- A. Model and serial number. (See page 8 or the ratings plate on the side of the water heater.)
- B. Address where the water heater is located.
- C. Name and address of installation contractors (page 8) and all qualified service companies that have worked on the water heater.
- D. Original installation date. (See page 8.)
- E. Dates any service or preventive maintenance was performed.
- F. Details of the persisting problem.
- G. List of businesses that have tried to fix this problem, along with dates of service.